



# Efento

# NB-IoT wireless logger

(Model HC5)

User manual

FW v 06.09.X

25.03.2022

# Table of contents

<b>Table of contents</b>	<b>1</b>
<b>Product overview</b>	<b>3</b>
Product description	3
Physical dimensions	5
Operating Modes	5
LEDs	6
<b>Getting started</b>	<b>6</b>
SIM card	6
Battery	6
Logger's startup	7
<b>Configuration</b>	<b>8</b>
Configuration with Efento Cloud	8
Configuration with a custom server	9
Device settings	12
<b>Logger status</b>	<b>18</b>
Cellular status	18
Battery status	19
Installation mode	19
<b>Software updates</b>	<b>20</b>
<b>Troubleshooting</b>	<b>20</b>
<b>Appendices</b>	<b>22</b>
Sensor specific settings: Pulse counters	22
Sensor specific settings: Binary (ok / alarm) loggers	26
Sensor specific settings: Water leak sensor	27
Sensor specific settings: CO2 sensor	28
Sensor specific settings: Barometric pressure	31
Sensor specific settings: High and low temperature	31
Sensor specific settings: Soil moisture	32
Sensor specific settings: Motion / presence sensor	33
Security	35
Power saving features	35
Data usage	36

Battery life	36
<b>Qualification and approvals</b>	<b>38</b>
European Union regulatory compliance	38
Compliance with the RoHS directive	38

## Product overview

### Product description

Efento NB-IoT loggers transmit the data over cellular networks (Narrowband IoT) and do not require any additional devices (router, gateway, etc.). Loggers are also equipped with Bluetooth Low Energy interface, which allows quick and easy configuration with a smartphone.

Loggers measure a number of parameters, including temperature, humidity, air pressure, soil moisture, state (open / close), number of pulses (pulse counters), air quality and various gases or water leakage.

Efento NB-IoT loggers communicate over CoAP protocol ([RFC 7252](#)) and can be integrated into any cloud platform or server based solution. Loggers can also work out of the box with the [Efento Cloud](#) platform. Devices can be fully managed remotely, including the remote configuration and secure software over the air (SoTA) updates.

Loggers are battery powered and can operate (depending on the signal quality and transmission interval) up to 10 years without any maintenance. In case of good signal quality (ECL = 0), the device is able to transmit the data up to 195 000 times.

### Technical data

<b>Cellular module</b>	3GPP Release 13 Power 23 dBm NB-IoT bands: <ul style="list-style-type: none"><li>• 8, 20 (PCB antenna)</li><li>• 1, 2, 3, 4, 5, 8, 12, 13, 17, 18, 19, 20, 25, 28, 66 (u.fl antenna)</li></ul>
<b>Battery</b>	<ul style="list-style-type: none"><li>• Battery pack 3.6V, 4200 mAh (up to 130 000 transmissions in ECL 0, lifetime up to 10 years) (default)</li><li>• Battery pack 3.6V, 6300 mAh each (up to 195 000 transmissions in ECL 0, lifetime up to 10 years)</li></ul>
<b>Measured values</b>	Each logger can have up to three slots Each slot can measure: temperature (internal sensor or probe), humidity (internal sensor or probe), air pressure, VOC, open/close, pulse counter, leakage

<b>Measurement and transmission intervals</b>	Configurable by user Measurement interval: 1 minute – 10 days Transmission interval: 1 minute – 10 days
<b>Memory</b>	60 000 measurements If there is no network connection, the device buffers the measurements in its internal memory and transfers them to the platform once the connection is re-established. Once the memory is full, the oldest measurements are replaced with the new ones
<b>Communication protocols</b>	CoAP (RFC 7252), supports both confirmable and non-confirmable data frames  Data is sent in Protocol buffers (protobuf)  Bluetooth Low Energy (for communication with smartphones)
<b>SIM card</b>	Micro SIM (3FF) (default) Embedded SIM (available on request)
<b>Network settings</b>	APN (auto or manual) PLMN (auto or manual)
<b>Indicators (troubleshooting)</b>	LEDs signaling the status of the device  Device information, which can be requested by the server include: signal strength in dBm, total power in dBm, TX power in dBm, cell ID, ECL, SNR, EARFCN, PCI, RSRQ, total transmitted bytes, total received bytes, battery voltage, uptime  Diagnostics data, including the network parameters and network connection status, is also available over Bluetooth
<b>Mechanics</b>	Enclosure material: ABS Size: 28 x 60 x 124 mm, 110 g Probes length (for loggers with probes only): by default 1 meter, other lengths are available on request Operating range: -35°C to +70°C Mounting: double side adhesive tape with acrylic glue or 2 x M3 screws
<b>Certifications</b>	CE, RoHS

## Physical dimensions

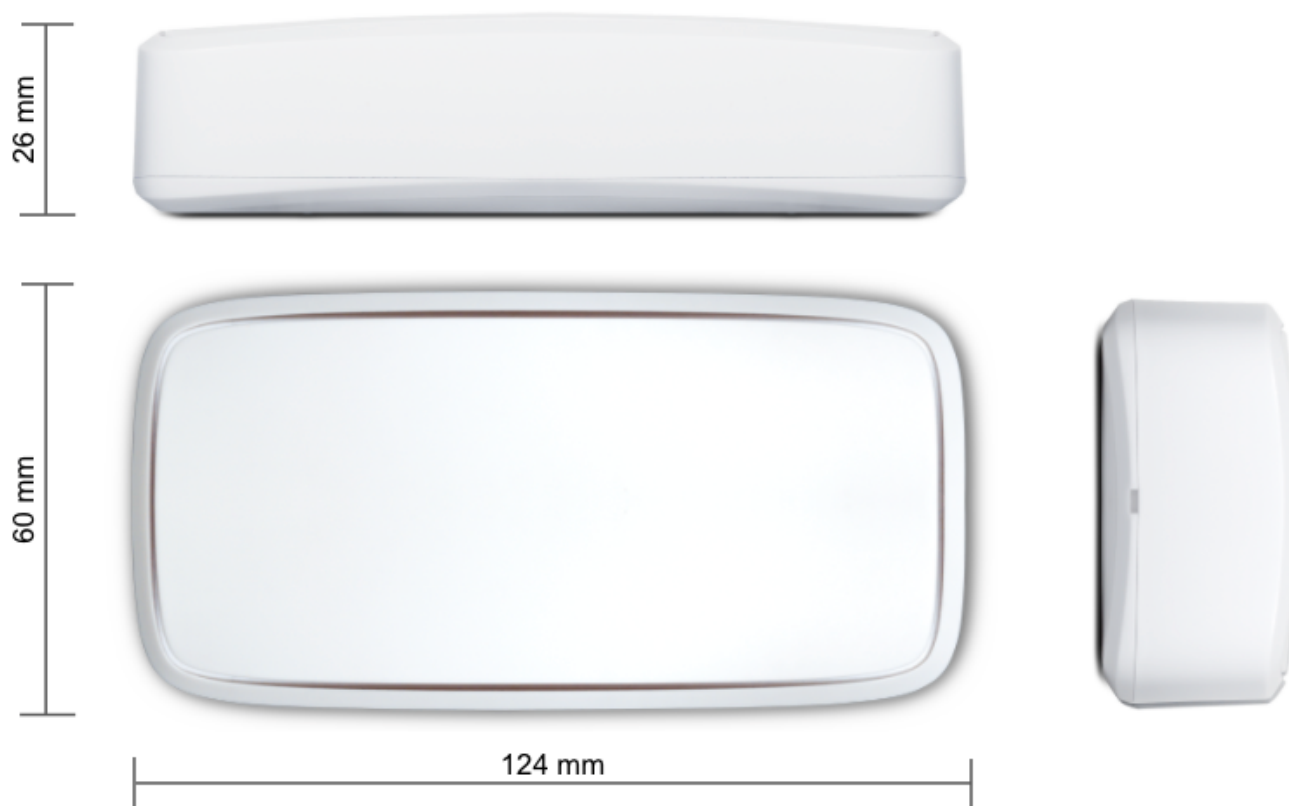

## Operating Modes

### **Power saving mode (PSM)**

This is the mode of the reduced power consumption. The logger takes measurements with a period set by the user and saves them in its memory. Users can read the measurements and change the logger's settings using mobile devices with Efento mobile application installed. Device does not send / receive any data over the NB-IoT network.

### **Transmission mode**

In this mode, the logger sends the data to a server / cloud platform over the NB-IoT network. During the transmission mode the logger consumes more power, but it only stays a few seconds in this mode. Devices can receive a new configuration in the response sent by the server. Devices enter the transmission mode for a few reasons, including the periodic transmission of data, user triggered transmission, transmission due to a threshold exceedance or retransmission.

In order to save energy, the logger remains in power saving mode most of the time. Communication with the server is initiated by the logger only for the purpose of sending data and (possibly) receiving a new configuration from the server.

## LEDs

NB-IoT logger is equipped with two LEDs: green and red. If the device is on and works properly (device is in the Power Saving Mode), both LEDs are turned off all the time. Flashing of the diodes indicates the current status of the device or the action being performed by it. The LEDs are placed at the edge of the PCB and are visible through the cuts on the side of the logger housing. LEDs flashing indicate:

- Single blink of the red LED once every 15 seconds - problems with registering on the network
- Double blinking of the red LED - communication problem / no coverage (the has registered on the network). Retransmission mechanism is started: 1st retransmission after 15 minutes, 2nd after 30 minutes, 3rd after 1 hour, 4th after 2 hours, and then every 3 hours
- Two blinks of the green LED - the device has taken a measurement
- Fast blinking of the green LED - Transmission mode - data is sent over the NB-IoT network
- Red and green LEDs blink five times - Device starts up
- Fast blinking of the red LED - Device clears its internal memory (you can see it on the initial configuration of the device or when changing the measurement interval)

## Getting started

### SIM card

Efento NB-IoT loggers are available in two options: with a plastic SIM card (micro SIM / 3FF) or an embedded SIM (on request). The SIM card must support NB-IoT.

If your device has an embedded SIM, you do not need to insert a SIM card. Logger will register on a network as soon as you power it up.

Micro SIM card holder is placed on the PCB. In order to insert the SIM card you need to open the device enclosure.

**CAUTION:**

**Make sure that the logger is off when inserting the SIM card. Inserting the SIM card when the device is on may damage the logger!**

### Battery

By default the logger comes with a battery pack 3.6V 4200 mAh.



**CAUTION:**

**Danger of explosion if the battery is incorrectly installed. Replace only with the same or equivalent type.**



**Protect the environment! Battery must be recycled or disposed of properly. Follow your local regulations and guidelines regarding the battery disposal procedure.**

## Logger's startup

Once you insert a SIM card, switch on the device - open the enclosure and set the switch in the "ON" position. On the device startup:

1. Red and green LEDs should blink five times,
2. After that red LED should quickly blink for a few seconds (device clears it's memory),
3. Green LED should quickly blink for a few seconds (first transmission over NB-IoT network)

From now on, the device operates, takes the measurements and saves them in the memory.



# Configuration

## Configuration with Efento Cloud

Efento Cloud is a platform that receives and stores all the data collected by the loggers. On Efento Cloud you can preview all the measurements, export them as a PDF or CSV report and set up notifications. The key functions of Efento Cloud platform are:

- **Displaying the data** – measurements from loggers can be visualized in the form of a chart or table, just click on one of the devices in “Dashboard”. The chart range can be modified by dragging the cursor vertically and horizontally.
- **Generating reports** – To generate a report you can either click on one of the loggers, then “Reports”, select the time interval and entry, then choose to export it as a PDF or CSV, or go to the “Reports” section and do the same thing. In this section, you can also configure automatic reports, which will be sent to specified email addresses at the scheduled time (e.g. every month, every day).
- **Rules / notifications** – Efento Cloud can send SMS / email notification if the measured values are out of the safe range. Rules can be created in the “Rules” section. To create a rule, you need to choose one of the physical values, add recipients by typing their emails or phone numbers, and select for which loggers this rule will be active. There is also a possibility to delay the alarm
- **Alarms** – if any of the rules are violated, the alarm will be triggered and saved on the platform. All the historical alarms are visible in the “Alarms” section.
- **User management** – In the “Users” section you can invite users to your organization, remove them or change their roles and permissions.

This is only a short list of key functions of the Efento Cloud platform. For more information about the platform and full configuration manual please refer to [Efento Cloud User Manual](#).

Configuration of Efento NB-IoT loggers is done with [Efento](#) mobile application for Android devices that can be downloaded from Google Play.

1. Set up a new account on [cloud.efento.io](https://cloud.efento.io) and create a new organization. If you already have an account, skip this step.
2. Download and install [Efento](#) mobile application for Android on your device. When the application launches for the first time, the user is asked to decide how the application will be used - to communicate with Efento Cloud or with nearby devices. Select Efento Cloud and log in to your Efento Cloud account.
3. Tap on the main menu icon (three lines in the upper left corner) and select “Organisation settings” -> “Add loggers”. Follow the instructions on the screen to configure the logger and add it to your Organization.

4. Configure alert rules, which will send you an SMS / email notification, if the values measured by the logger are out of the safe range or if the logger data do not reach the platform. In the Efento mobile app go to the Main menu and select the “Alarm rules” tab, set up the rule and save the changes.



**If you set a rule for the logger (e.g. humidity over 40% RH), the value will be sent to the logger during the next communication. From that moment on, if the measured value exceeds the threshold, the logger will send the data to Efento Cloud immediately, no matter what the transmission interval is.**

## Configuration with a custom server

Efento NB-IoT loggers send data using the CoAP protocol ([RFC 7252](#) Constrained Application Protocol). CoAP is a lightweight UDP based data exchange protocol that is one of the standard IoT protocols. The data is sent in Protobuf format, which, thanks to its low overhead, is also very convenient for sending data by Internet of Things devices.

Efento loggers can be easily integrated with any server application. Integration allows users to access all the loggers' features in their application - this includes both receiving the data from the loggers and remotely configuring the devices. A detailed description of the data format sent in Protobuf is available in the "Efento NB-IoT Loggers Integration Manual". We can also provide you with a demo source code, which you can run on your server in order to communicate with Efento NB-IoT loggers. Should you have any questions about the integration, please contact our [support team](#).

The initial configuration of Efento NB-IoT loggers is done with [Efento](#) mobile application for Android devices that can be downloaded from Google Play. The application allows you to configure all parameters of the logger and read the measurements from the logger's memory. After that, the configuration can be either done locally or remotely, from a server.

After downloading and launching the app select the “Nearby devices” mode, you will see all the loggers that are in your mobile device's range.

Tap on the main menu icon (three lines in the upper left corner) and quickly tap Efento logo 10 times. This will activate the Power user mode and give you access to full configuration of Efento loggers.



**Activate Power user mode to get access to full configuration options of Efento loggers. To activate Power user mode, quickly tap 10 times on the Efento logo in the Efento application main menu.**

Tap on the logger you're interested in, the app will connect to it and show the logger's information along with its current configuration. To open up the settings menu, tap on the „three dots” icon in the upper right corner.

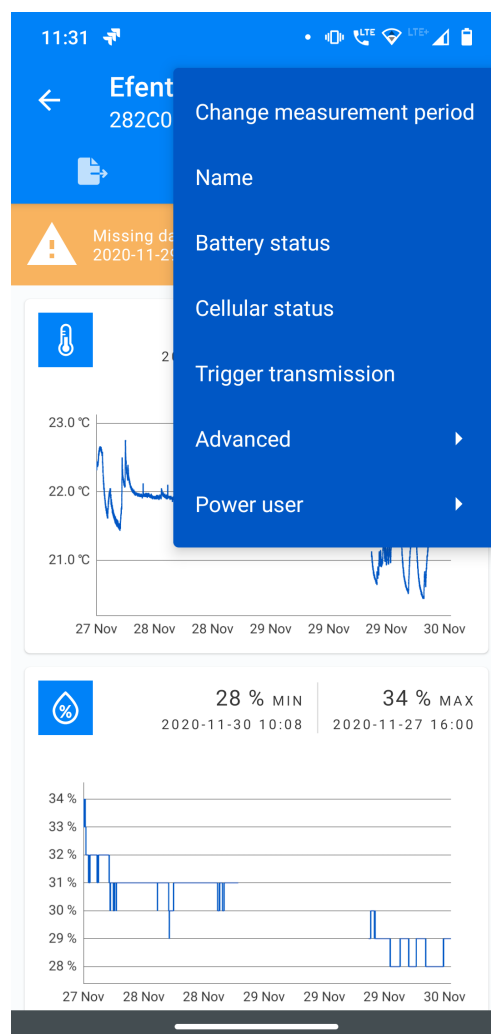
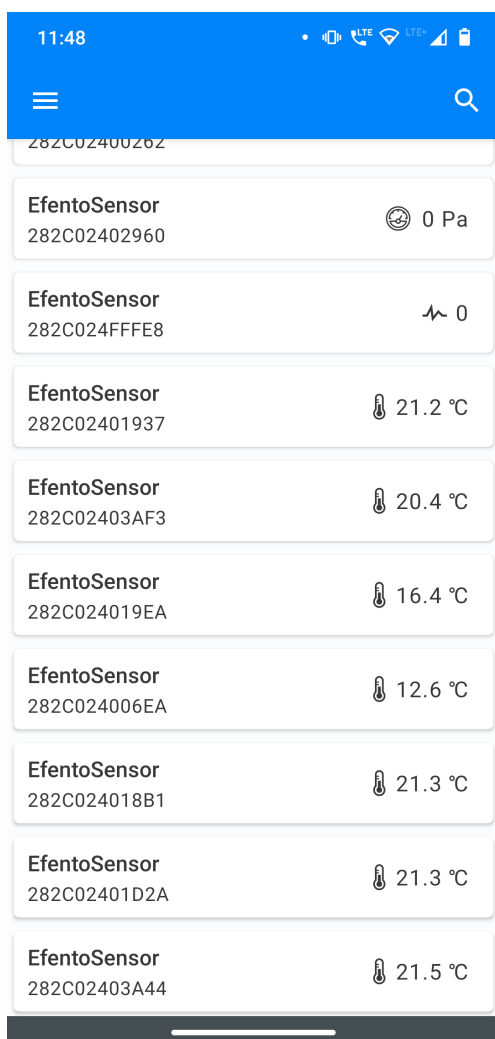

Tap on “Cellular status” in order to display the current status of the network communication. Check the value of the “Registration status” field.

If the value is:

- REGISTERED
- REGISTERED ROAMING

The logger has registered on the network. You do not need to change the network settings of the device.

If the value is:

- NOT REGISTERED, SEARCHING

The logger is still trying to connect to the NB-IoT network. Wait for 5 minutes and check the status again. It may also be required to manually select the network, on which the device has to register (this is described in the further steps of this manual)

If the value is:

- REGISTRATION DENIED
- REGISTERED EMERGENCY ONLY
- UNKNOWN

The device is not able to properly register on the network. Contact your mobile operator to identify and solve the issues. If the device has been rejected by the network, the reason will be listed in the “Registration reject cause”. Provide your operator with that value, to speed up the troubleshooting.

If the value is:

- NOT REGISTERED\_NOT\_SEARCHING

Most probably there is no NB-IoT network coverage in the place where the logger is located.

If the device has not registered on the network automatically, you need to manually select the carrier. Connect to the logger with Efento mobile application, go to the “Settings” menu and select “Power user” -> “PLMN code”. PLMN is a unique operator identifier. You should get the information about the PLMN code of your operator either from the operator or you can check it [here](#). Set the PLMN code, save changes and after a few minutes check, if the logger has successfully managed to register on the network.

In order to allow the logger to communicate with the server, you need to assign it to a proper APN. The APN (Access Point Name) is the name of a gateway between a mobile network and the public Internet. APN settings define what servers the loggers can communicate with. You should receive the information about APN settings along with the SIM card. If you did not receive the APN settings, try setting it to “Auto” (default settings).



**Check the required APN and PLMN settings with your mobile operator. If the settings are not correct the device will not be able to send / receive the data through the cellular network.**

In order to set the APN, connect to the logger with Efento mobile application, go to the “Settings” menu and select “Power user” -> “APN”.

After successful network registration, the device will fetch the time from the network. From now on, all the measurements taken by the device will have the timestamp assigned. If for any reason the device is not able to fetch the time from the network, it will try to connect to the Efento Cloud platform and get time from the server. If the connection with the server is also not possible (e.g. device communicates with a third party server, or APN is configured incorrectly), it is also possible to set the logger’s time using the Efento application.

During the registration process the logger saves the measurements in its volatile memory (RAM), and after fetching the time from the network, it will assign correct timestamps to the measurements. If the battery is removed before fetching the time from the network, these measurements will be lost.

If you set both PLMN and APN correctly, but the logger is not able to register on the network or communicate with the server, please refer to the “Troubleshooting” section of this manual.

Once the logger is successfully registered in the network, you can set the address of the server, to which the logger will send the data:

1. Connect to the logger with Efento mobile application, tap on the three dots in the upper right corner -> “Power user” -> “Server configuration”
2. Select “Other” and key in the address and port of the server, to which the data should be sent.
  - a. Efento sensors support DNS, but the recommended approach is to use the server’s IP address (sensor does not need to connect to DNS server in order to obtain the IP address of the data server). If you prefer to use DNS, make sure you configured the DNS server (“Power user” -> “DNS server”).
  - b. By default, the sensor will send the data to the “/m” endpoint. If you prefer to use a custom endpoint, you can configure it in the “CoAP endpoints” tab in the settings menu (“Power user” -> “CoAP endpoint”). CoAP endpoints can be set to any value (e.g. “/data”) or can be dynamically set, based on the sensor parameters (e.g. “/SENSORS\_IMEI”). In order to set the endpoint address dynamically, use targs: “#S” - sensor’s serial number, “#I” - sensor’s IMEI, “T” - sensor’s cloud token. You can use the tags in the endpoints in any way you like - e.g. setting the endpoint address to “data/#I” will set the endpoint to “/data/SENSORS\_IMEI”
3. If you want to, you can use the “Organisation token” field to send additional information to the server (e.g. API token). Optionally, you can set the logger to send its IMEI to the server. To switch that option on, select the checkbox “IMEI as token”.

## Device settings

All the settings of Efento loggers described in this chapter can be also done remotely, from the server. In order to get the information on how to configure the device remotely, please refer to “Efento Cloud User Manual” or to “Efento NB-IoT Loggers Integration Manual”.

Settings described in this section are available for all logger types. On top of these, some sensor types have additional settings. Those settings are described in the “Sensor specific settings” section.

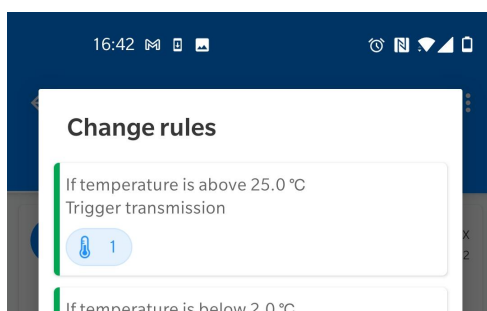

## Rules

Users can set up to twelve edge logic rules on the device. Each rule is an “if **condition** is met, trigger an **action**” statement.

Moreover, it is possible to add some mathematical operations to the conditions and build statements like “If the average value of the last five measurements is over...”. Rules are used to limit the

number of transmissions done by a device and increase the battery life time.

## Conditions

Available conditions:

- **Above threshold** - if a measurement taken by the logger is higher than the threshold value, the transmission to the server will be triggered. It is possible to set hysteresis for this type of condition
- **Below threshold** - if a measurement taken by the logger is lower than the threshold value, the transmission to the server will be triggered. It is possible to set hysteresis for this type of condition
- **Differential threshold** - if the absolute value of the difference between the current measurement and the last measurement sent to the server, the transmission to the server will be triggered

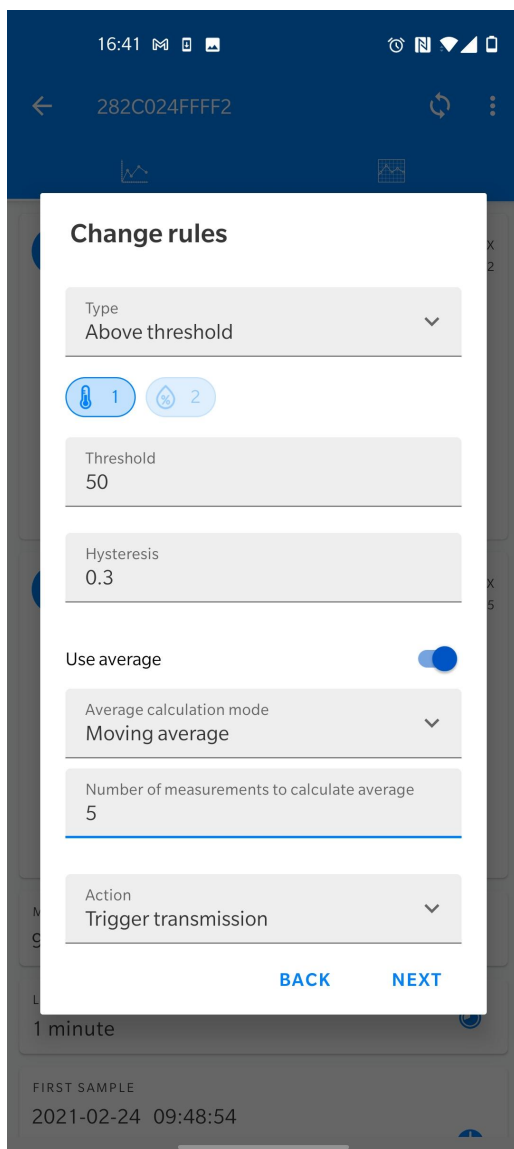

Users can also set the logger to calculate the average value out of a few measurements and compare this value to the differential threshold value. This feature is used to reduce the effect of measurement fluctuation. For example, a user can set the logger to compute the average value of five temperature measurements, and check if the difference between the last sent measurement and the average value is larger than 0,5 C.

## Averages

There are two modes for the average value calculation:

- **Moving average mode** - device calculates the average value out of the last N samples. If there is a new measurement, it is taken to the average value calculation instead of the oldest one. Users can define how many measurements should be taken into the account when calculating the average value. For instance, if the user sets the device to calculate the average value from the last three samples, the device will calculate the average value from samples N-2, N-1 and N. Once a new measurement is taken, the average value will be calculated from samples N-1, N, N+1.
- **Window mode** - device calculates the average value out of all samples in the window size. The window 'moves' once the device has taken a number of measurements equal to the window size. Users can define how many measurements should be taken into the account when calculating the average value. For instance, if the user set the device to calculate the average value from the last three samples, the device will calculate the average value from

samples N-2, N-1 and N. The new average value will be calculated as soon as the device has taken three new measurements (N+1, N+2, N+3).

## Hysteresis

Hysteresis allows to filter out small fluctuations in order to eliminate a large number of data transmissions, if the measurements taken by the sensors are close to the threshold value. Hysteresis value defines the range above and below the threshold value that are still acceptable and won't trigger the transmission.

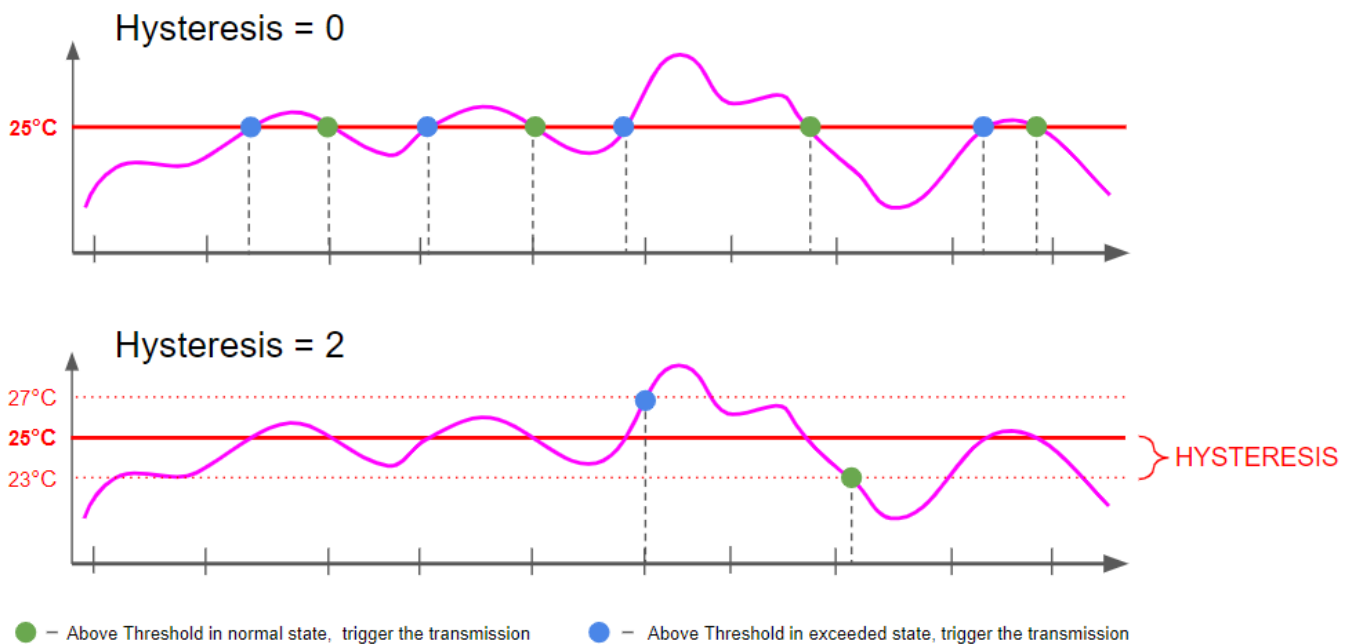

## Actions

It is possible to set two types of actions:

- Trigger transmission - if a condition is met, the device will immediately trigger the transmission to the server
- No action - no action will be taken. This setting is used when building more complex logical rules, which combine two basic rules. E.g. "If Condition 1 and Condition 2 are met, trigger the transmission" (described in the further part of the user manual).

## Setting up a rule

In order to create a new rule:

1. Connect to the logger, tap on the three dots in the upper right corner -> "Power user" -> "Rules"

2. Select one of the rules slots. All slots are treated equally, so it does not matter to which slot you assign the new rule. Each time a device takes a measurement, it checks if any of the rules is violated.
3. Select the condition type, channel (if a device measures e.g. temperature and humidity you can set the rule for one of the channels), threshold value, hysteresis, average mode. This parameters define the rule's conditions
4. Set the action type and save the changes

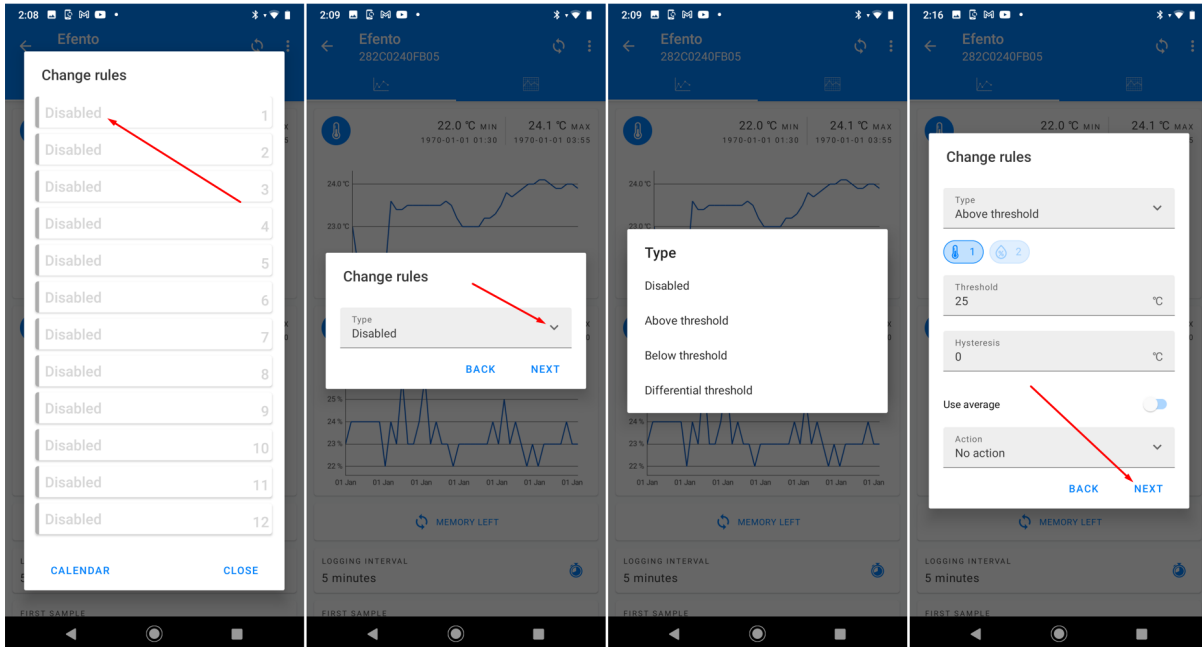

If you want to remove a rule, tap on it, set the Condition to “Disabled” and save the settings.

## Logical rules

Logical rules allow creating more complex rules on the sensor. For instance, it is possible to create a rule saying: “If temperature is over 25°C AND humidity is over 50% RH, trigger the transmission to the server”. Logical rules allow building logic using three logical operators: AND, OR, NOT.

In order to create a logical rule, you need to create at least two standard rules, which will be combined in the newly created logical rule.

1. Connect to the logger, tap on the three dots in the upper right corner -> “Power user” -> “Rules”
2. Select one of the rules slots, and create a new rule of “Logical” type
3. Select the condition type:
  - a. All rules are met - the action will triggered, if both conditions are met (AND)
  - b. At least one of the rules is met - the action will triggered, if any condition is met (OR)
4. Set the action type and save the changes



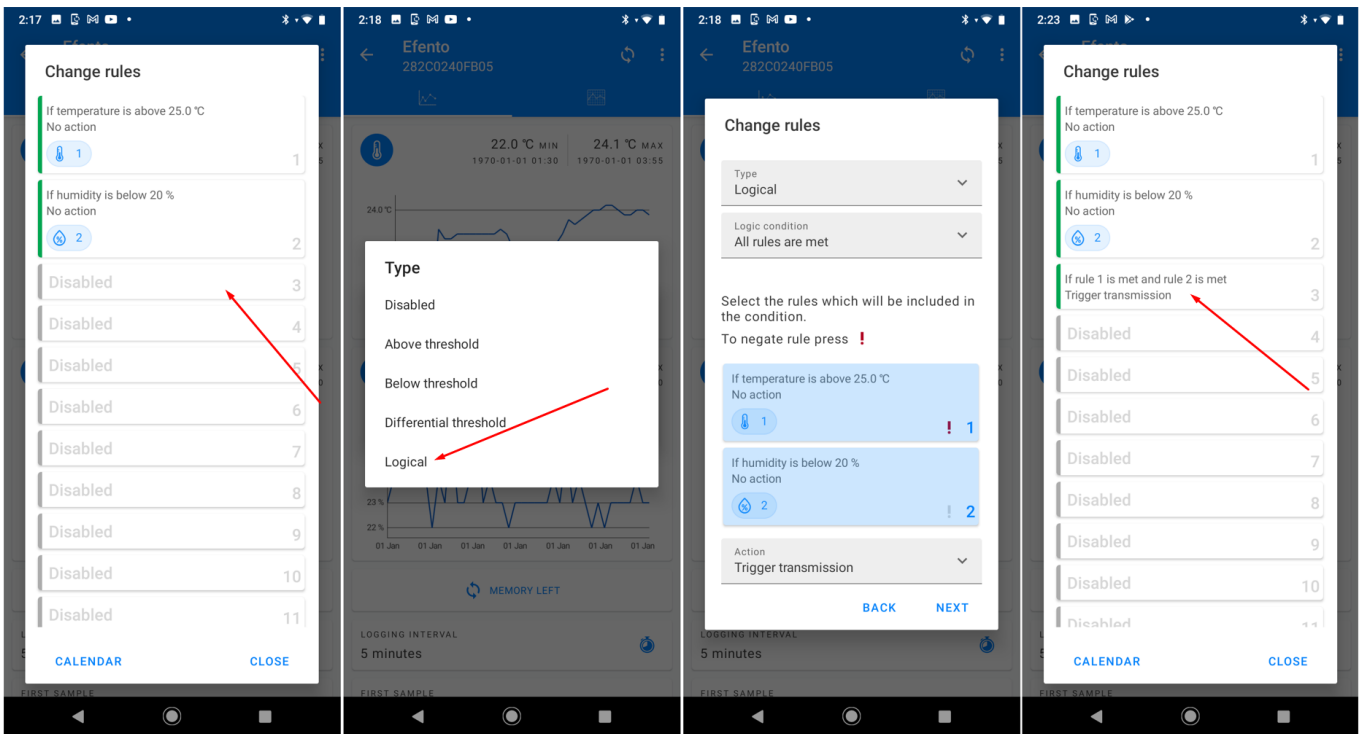

When creating a logical rule, it is possible to negate (NOT) individual rules by pressing the exclamation mark (!) next to them. Example: original alarm rule's condition: "If the humidity is over 35% RH" negated alarm rule "If the humidity is NOT over 35%"

If you want to remove a logical rule, tap on it, set the Condition to "Disabled" and save the settings.

## Calendars

Calendars allow enabling rules (both standard and logical rules) only on the selected days and times. This allows users to create rules like "If temperature is over 25°C on Mondays between 8 AM and 5 PM, trigger the transmission to the server" or "If temperature is over 25°C AND humidity is over 50% RH on Saturdays and Sundays, trigger the transmission to the server". Users can set up up to six calendars and assign rules to them. Note, that more than one rule can be assigned to a single calendar.

To create a rules calendar:

1. Create at least one alarm rule (standard or logical)
2. From the rules menu select "Calendar" and create a new Weekly calendar on an empty slot

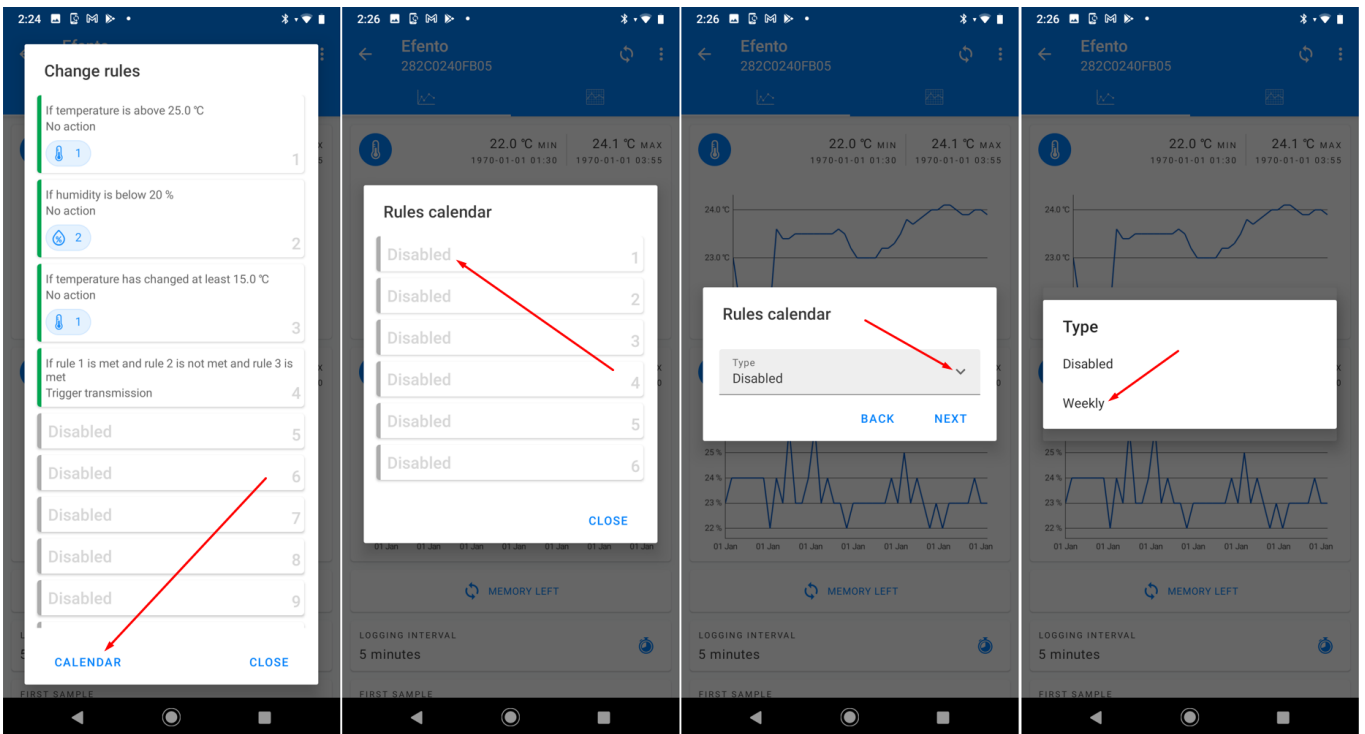

3. Define days and times on which the calendar is active (you can select multiple week days)
4. Assign the rules to the calendar

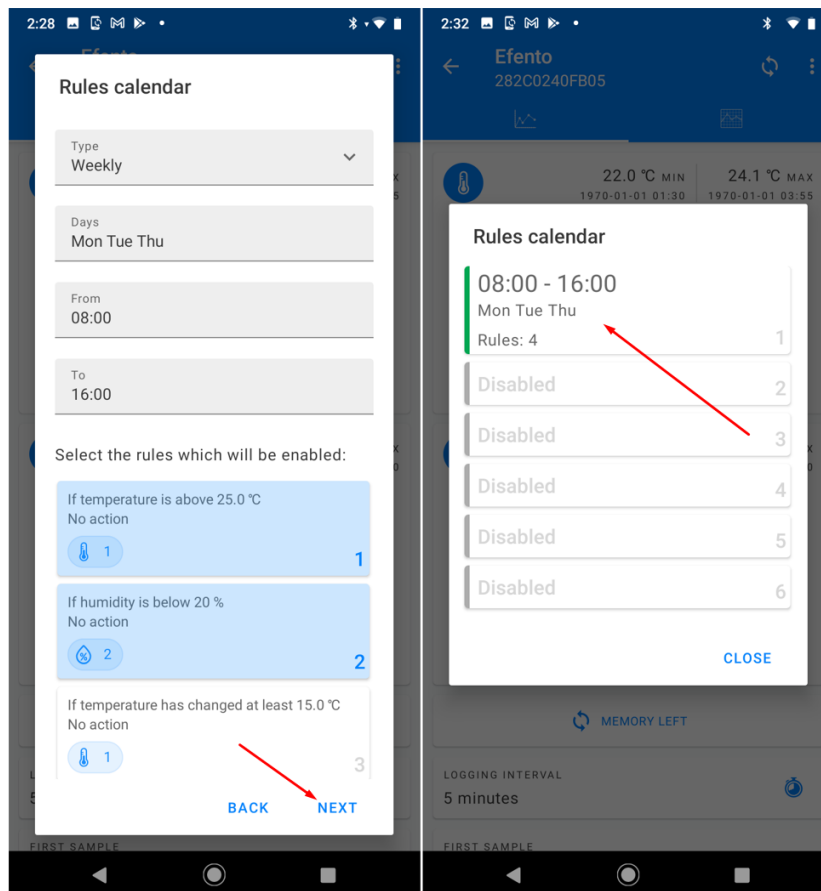

If you want to remove a calendar, tap on it, set the Condition to “Disabled” and save the settings.

## Measurement interval

Measurement interval defines how often the logger takes a measurement. It is possible to set the measurement interval to any value from 1 minute to 10 days. Changing the measurement period does not remove measurements from the device’s memory by default.

In order to change the measurement interval:

1. Connect to the logger, tap on the three dots in the upper right corner -> “Change measurement period”
2. Set the new measurement interval and save changes

In order to change the measurement interval and remove all the measurements from the device’s memory:

1. Connect to the logger, tap on the three dots in the upper right corner -> “Change measurement period”
2. Set the new measurement interval, select “Clear memory” and save changes

## Transmission interval

With this parameter you can set how often the logger sends data to the Efento Cloud platform or a server. You can set any value from 5 minutes to 10 days. The maximum value of the transmission interval depends on the measurement interval - it can be set to 60 times the measurement interval (e.g. measurement interval = 1 minute, transmission interval can be set to any value from 5 minutes to 60 minutes).

If the logger works with Efento Cloud, the platform informs the user when the new data from the device is expected.

509 28 2C 02 40 3E 59	15	WARSZTAT	✓	25.0 °C 48%	Next update in 1 hour 36 minutes	★
509 28 2C 02 4D DD D2	34	WARSZTAT	✓	Alarm 2020/08/05, 16:23	16:23:35 2020/08/05	★

Additionally, it is possible to configure how often the message sent by the logger requires confirmation of receipt by the server (ACK). If the ACK is not received by the logger, it will retransmit the data to the server. The confirmation frame (ACK) is used also to send a new configuration to the device.

Type of messages sent by the loggers depend on the use case. If your use case requires all the messages to reach the server, then you should set the logger to always require the ACK. If your use case is not critical, and you are aware that some data frames can be lost, you can set the device to require the confirmation less often (e.g. every 24 hours). This will increase the battery lifetime, as the device stays in the transmission mode for less time.



**Do not set the ACK interval to more than once every 24 hours. Device gets new configuration from the server in the ACK frames**

Logger stores up to 60 000 measurements in its memory. In case of any issues that block the communication between logger and server (network issue, server issue, etc.), if the ACKs are enabled, the logger will resent the missing data to the server.

In order to set the transmission interval:

1. Connect to the logger, tap on the three dots in the upper right corner -> "Advanced" -> "Sending interval"
2. Set the new transmission interval - remember that it can't be less than measurement interval and more than 60 times the measurement interval
3. Set the ACK interval. You can set it to:
  - a. **Always** - every data frame sent by the logger will require the ACK from the server. If the data has not reached the server, it will be retransmitted once the connection is reestablished
  - b. **Every** - you can set how often the device should require the ACK from the server (e.g. every 3rd transmission, every 24th transmission). This is a good balance between making sure the data reaches the server and battery lifetime



**In order to make sure that all the measurements reach the server, set the ACK interval to "Always". In case of any transmission issues, the logger will try to resend the data until it succeeds.**

## Transfer limit

Efento NB-IoT logger allows you to limit the number of transmissions in a given period of time. For instance, you can set the device to be able to send the data maximum 5 times in a 30 minutes window. This feature allows you to control the battery life time in an environment, in which the small fluctuations of the measurements would trigger the transmission very often. By default this function is disabled (there is no transfer limit set).

You can set up two parameters of the transfer limit function: number of transmissions (N) and time period (T). After each successful transmission a transmission counter increments by 1. The counter decrements every time period (T). If a transmission is triggered, but the counter is equal or greater than the set number of transmissions (N), the communication with the server is blocked, until the counter derements to a value below the number of transmissions (N). This applies only to regular transmissions and threshold triggered transmissions. Transmission triggered over Bluetooth will always be sent to the server.



**If you enable the transfer limit, the device may not be able to send the data to the server, even if an alarm threshold has been exceeded!**

In order to set the transfer limit:

1. Connect to the logger, tap on the three dots in the upper right corner -> "Power user" -> "Transfer limit"
2. Enable the transfer limit and key in the number of transmissions and the time period for the transfer limit function

## Bluetooth turn off time

You can set up the logger to automatically switch off the Bluetooth interface after a selected period of time. This increases the battery lifetime but you will not be able to connect with the logger and change its configuration with your mobile device. By default the Bluetooth interface is always on.

If the Bluetooth has been turned off, in order to enable it you either need to restart the device (switch it off, wait for 10 seconds and switch it on again) or turn it on remotely, from the server.

In order to set the Bluetooth turn off time:

1. Connect to the logger with Efento mobile application, tap on the three dots in the upper right corner -> "Power user" -> "BLE turn off time"

## Encryption (Bluetooth)

Enabling the encryption will result in encrypting the data sent by the logger over Bluetooth Low Energy interface. The encrypted data sent by the logger can only be decrypted by a device with the encryption key.

This feature is useful, if you need to be sure that only the authorized personnel can read the data over Bluetooth interface. Users who do not know the encryption key, will not be able to read the data.

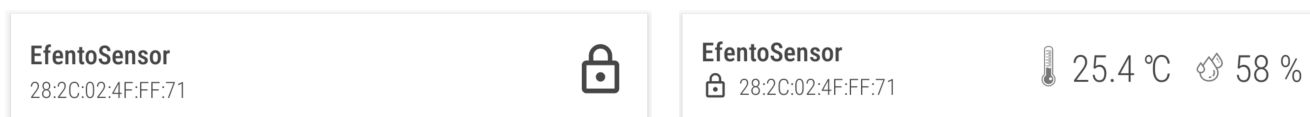

*If the logger communication is encrypted, only devices with a proper encryption key can read its measurements (right). Devices without the encryption key are not able to read the data (left)*

In order to set the encryption key:

1. Connect to the logger with Efento mobile application, tap on the three dots in the upper right corner -> "Advanced" -> "Turn encryption on"
2. Key in the encryption key. Make sure you write it down as you will need to add it in mobile devices that will access the logger data
3. From now on, the communication is encrypted. You will need to add the encryption key in Efento in order to see the data sent by the logger

In order to switch the encryption off:

1. Connect to the logger with Efento mobile application, tap on the three dots in the upper right corner -> "Advanced" -> "Turn encryption off"

If the encryption has been turned on, once you try to connect to the logger with Efento mobile application, you will be asked to key in the encryption key. Once you add it, the application will store the encryption key and you will be able to access the logger without adding it again.

Efento mobile application allows you to add up to five default encryption keys. If a logger communication is encrypted with any of the added keys, Efento mobile application will automatically decrypt the data. This is useful for managing a fleet of loggers.

In order to add a default encryption key in Efento mobile application:

1. Enter the application settings (menu icon in the upper left corner -> "Configuration")
2. Select "Default keys"
3. Press "Add encryption key" button
4. Add the encryption key and its label

If you want to delete an encryption key:

1. Enter the application settings (menu icon in the upper left corner -> "Configuration")
2. Select "Default keys"
3. Tap and hold the encryption key you want to remove

## Device time

In order to operate properly, Efento NB-IoT logger has to set its internal time. After successful network registration, the device will automatically fetch the time from the network. From now on, all the measurements taken by the device will have the timestamp assigned. If for any reason the device is not able to fetch the time from the network, it will try to connect to the Efento Cloud platform and get time from the server. If the connection with Efento Cloud is also not possible (e.g. device communicates with a third party server, or APN is configured incorrectly), it is also possible to set the logger's time using the Efento Logger application.

In order to set the time:

1. Connect to the logger with Efento mobile application, tap on the three dots in the upper right corner -> "Power user" -> "Device time"
2. Logger will get the time from your mobile device. If the time set on your mobile phone is wrong, the logger will also have wrong time settings

Logger synchronizes the time settings with the network every time it communicates. If you manually set the time and the logger will be able to fetch the time from the network, it will overwrite the manual settings.

## Restoring default (factory) settings

In order to restore the default settings: connect to the logger with Efento mobile application, tap on the three dots in the upper right corner -> “Advanced” -> “Restore default settings”.

## Logger status

Efento loggers collect information about its current status. This information is useful for troubleshooting and solving the connectivity issues. Information about current logger status can be accessed with the Efento Logger application or remotely, from the server. If you want to integrate Efento loggers into your cloud / server platform and want to receive the information about the logger status, please refer to “Efento NB-IoT loggers integration manual”.

## Cellular status

Current device’s cellular status can be checked in the “Cellular status” tab (connect to the logger -> three dots in the upper right corner -> “Cellular status”). In the tab, you can see the following information:

- **Supported technologies** - what cellular technologies are supported by the device. There are two options: NB-IoT or NB-IoT & LTE-M
- **Current technology** - what technology is currently in use. For NB-IoT only loggers it will always be NB-IoT, For NB-IoT & LTE-M logger, current technology depends on the technology which is currently in use. Devices automatically switch between technologies, depending on the inserted SIM card
- **Registration status** - indicates current network communication status:
  - REGISTERED - registered to the network - this is typical status of the device;
  - NOT REGISTERED, SEARCHING - not registered to the network, searching for it - this status may be seen during device power up, when it did not manage to attach to the network yet;
  - NOT REGISTERED\_NOT\_SEARCHING - not registered to the network, not searching for it - this status is seen mainly, if there is no network coverage;
  - REGISTRATION DENIED - network did not allow device to register
  - REGISTERED ROAMING - if the device is registered in roaming
  - REGISTERED EMERGENCY ONLY
  - UNKNOWN - all the other states
- **Registration reject cause** - if the device is not able to register to the network, the cause is displayed in this field. Reject causes are described in 3GPP TS 24.301 Annex A
- **Signal strength** - strength of the signal
- **Communication status** - describing current status of communication with the server. Possible statuses: OK, server error, encoding error, socket error, timeout, mismatch, unauthorized, unexpected error, not registered, not supported
- **IMEI** - IMEI number of the cellular module
- **ICCID** - ICCID of the SIM card in the device
- **IP address** - current IP address of the device

- **ECL** - ECL level. This parameter is a good indicator of the signal quality. The lower, the better. ECL 1 or 2 may significantly reduce the battery life
- **Cell ID** - ID of the cell in to which the device is connected
- **Last communication timestamp** - timestamp of the last successful communication. All the information on this card is refreshed during the communication / self check.
- **Last status check timestamp** - timestamp of the last self check. Self checks are performed on the startup or may be performed on server's demand. All the information on this card is refreshed during the communication / self check.

## Battery status

Efento loggers will inform you about the low battery level both on Efento Cloud platform and in Efento Logger mobile application. Once a "low battery" status shows up, you will have 2-3 months to replace the battery.

Efento loggers allow you to get the detailed information about the battery voltage and operation parameters. In order to get the detailed battery parameters, connect to the logger with Efento mobile application -> three dots in the upper right corner -> "Battery status".

You can get the following information:

- **Battery status** - information if the battery has to be replaced ("LOW") or not ("OK")
- **Battery Voltage** - current voltage of the battery in mV
- **MCU temperature** - current temperature of the processor
- **MCU min temperature** - lowest temperature of the processor
- **MCU max temperature** - highest temperature of the processor
- **Battery min voltage** - lowest voltage of the battery
- **Battery reset timestamp** - beginning of the battery monitoring period

## Installation mode

In the installation mode, the device continuously communicates with the network and Efento Cloud for 300 seconds (5 minutes), refreshing the signal strength and connection parameters. Starting the installation mode allows you to check whether the logger correctly logs into the network and whether the signal strength of the NB-IoT network is sufficient for the correct operation of the logger. Launching the installation mode is not required for the correct device configuration. After starting installation mode, the user can check:

- **Seconds left** - the number of seconds remaining until automatic exit from the installation mode
- **Signal strength** - NB-IoT signal strength in tenths of dBm. -120 is taken as the extreme value. If the signal strength is below this value, the device may regularly lose connection and not be able to correctly send data to the server
- **Signal Quality** - parameter defining the signal quality
- **Last data fetch Timestamp** - date and time of the last communication with the network. All parameters related to communication with the network have been refreshed at this time
- **Registration Status** - network connection status. There are three possible statuses:



- 
- REGISTERED - registered on the network
  - NOT REGISTERED SEARCHING - not registered on the network, trying to find the network and register on it.
  - NOT REGISTERED NOT SEARCHING - not registered on the network, does not try to search for the network and register to it. If the logger cannot register on the network for any reasons (e.g. poor signal quality, SIM card error), this status will appear after several unsuccessful registration attempts
  - **Ping status** - information if the logger is able to reach Efento Cloud platform. Ping status allows you to verify the correct configuration of the APN - if the device is connected to the network, but does not communicate with the platform, it is most likely caused by a wrong APN configuration
  - **Firmware Version** - logger's software version

## Software updates

Logger software can be updated in two ways:

- **Remotely (Software Over The Air)** - the Efento team, after preparing and testing the new software version, can remotely update the software on all connected loggers. The software update is done by sending to the logger only the difference between the new software version and the current version. Thanks to this, the consumption of battery and data transmission during the update is limited, which extends the working time of the logger. This type of update does not require any action on the user side and is done in a way that does not have any impact on the operation of the device.
- **Locally** - wirelessly using Efento Logger mobile application. This update method is mainly used to upload test software versions provided by the Efento technical support team. To update sensor's software locally connect to the logger with Efento mobile application -> three dots in the upper right corner -> "Advanced" -> "Update firmware from a file".

## Troubleshooting

### Logger doesn't switch on

If red and green diodes keep blinking, it means that the logger is in a reset loop due to the low voltage of the battery. To solve this problem, replace the battery pack with a new one.

### Logger doesn't send the data

If the logger is taking measurements, and they are visible in Efento Logger, but it doesn't send the data to Efento Cloud please check:

- SIM card – make sure that SIM card is active and dedicated for NB-IoT / LTE-M devices
- Range – make sure that there is NB-IoT / LTE-M coverage in the place where you want to use the logger

- 
- APN settings – some networks require manual APN set up. Please contact your operator and obtain APN configuration. Set APN with Efento Logger as described in Step 4.
  - If the device is able to fetch time from the network - Efento loggers need to fetch the time from the NB-IoT network in order to synchronize internal time with the network time. If this feature is not available, you can set the time manually with Efento Logger by using the “Change device time” option.
  - Temperature in which logger operates – If the temperature is below the range declared in the datasheet, the logger will not be able to send the data over NB-IoT. This is due to the voltage required by the NB-IoT module. If you need to measure low temperatures, please use the logger with an external temperature probe

## Other problems

If you experience any other problems with Efento NB-IoT loggers, please contact our [support team](#). We will be happy to assist you.

## Appendices

### Sensor specific settings: Pulse counters

Pulse counters are special types of sensors that are used to count the number of pulses provided by a third party device / meter. There are various use cases of the pulse counters, including reading water / electricity / gas meters or counting the number of events (e.g. door opening and closing).

Efento offers three types of pulse counters: water pulse counter, electricity pulse counter and generic pulse counter. From the hardware perspective, the devices are identical. The only difference is on the software side - the water pulse counter converts the number of pulses to litres, electricity pulse counters convert the number of pulses to Wh and the generic pulse counter returns the number of pulses counted in the set time period.

### Connecting pulse counters

Efento pulse counters can be equipped with three channels, each of them counting the pulses separately. **Efento pulse counters support devices, which provide SO pulses (dry contact)**. The device, which provides pulses should be wired to Efento pulse counter's CH and GND pins (in case of a multi-channel pulse counter: CH1-GND, CH2-GND, CH3-GND)

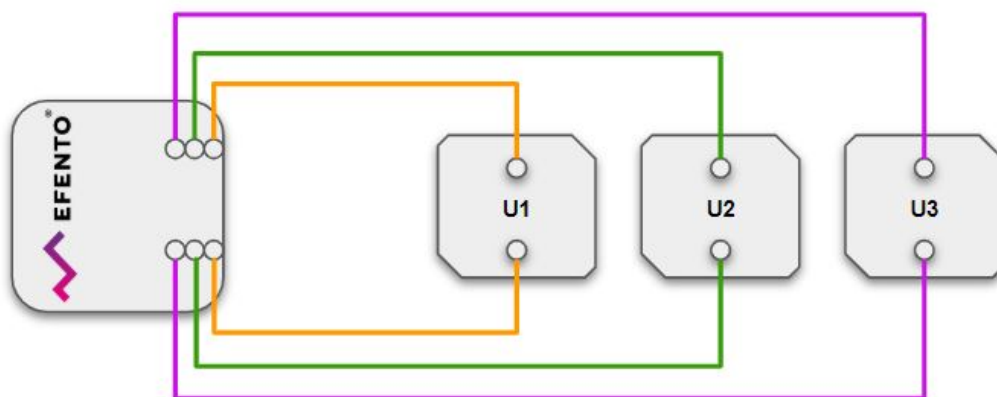

*Efento pulse counter / water pulse counter - wiring scheme*

**IMPORTANT!** If you want to connect the water pulse counter to an analogue meter, you can use a pulse probe (depending on the meter manufacturer, it can also be called pulse sensor, pulse generator) to convert the indication of an analogue meter to pulses. Check the user manual of your water meter to find the best way of converting the meter's readings to the pulses.



## Pulse counters wiring scheme

Efento pulse counters can support up to three channels. Wiring scheme depends on the number of channels.



## Pulse counters settings

Efento pulse counters have the same features as regular Efento loggers. On top of the standard features users can configure pulse conversion ratio, maximum pulse duration, debounce time and reverse the logic of the pulse counters.

## Conversion ratio

Efento water and electricity pulse counters allow users to set the conversion ratio for each of the channels. Pulse counter will convert the number of pulses counted in the set period of time based on this ratio. For instance, if the user sets the water meter's conversion ratio to '1', the device will treat a single pulse as 1 litre. If the conversion rate has been set to '10', each pulse will represent 10 liters. In case of the electricity pulse counters, users may set the number of Watt-hours (Wh) represented by a single pulse.

In order to change the conversion rate, connect to the device, and from the settings menu select "Advanced" -> "Calibration" -> "Calibration parameters" -> "Select a channel" -> "Conversion ratio".

## Maximum pulse duration

It is possible to set the maximum length of a pulse accepted by Efento Pulse Counter. If a pulse counter receives a pulse longer than the set value, it will be considered as an error and reported over NB-IoT / Bluetooth. This feature is useful, if the pulse counters work with utility meters equipped with pulse outputs with defined pulse lengths. By setting the maximum accepted length of a pulse, the user may control the correct operation of the meter. By default the pulse duration control is off and pulse counters treat all pulses length as acceptable.

In order to change the conversion rate, connect to the device, and from the settings menu select “Advanced” -> “Calibration” -> “Calibration parameters” -> “Select a channel” -> “Pulse timeout”.

## Debounce time

This parameter allows the sensor to be protected against counting pulses in the event of electrical interference, which can be caused by machines located in the place of installation or by connecting a pulse counter and a meter with a long cable. Excessive pulses may also be caused by what is commonly known as contact bouncing. Setting the debounce time switches on the impulse counting lock from the moment of the change of state on the impulse counting input for the time specified by the user. In the example below, debounce time is set to 300 ms.

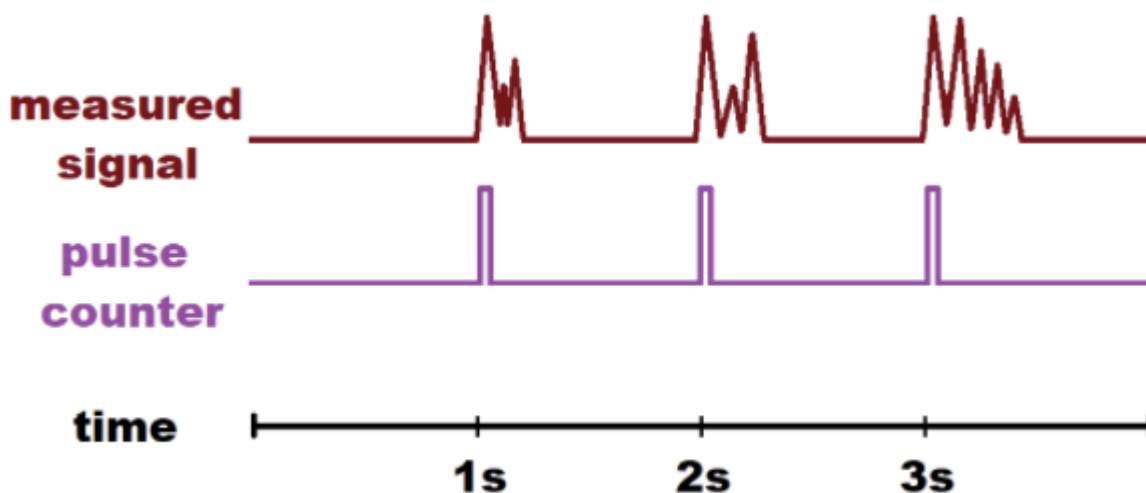

In order to change the conversion rate, connect to the device, and from the settings menu select “Advanced” -> “Calibration” -> “Calibration parameters” -> “Select a channel” -> “Debounce time”.

---

## Reverse logic

Pulses are counted by shorting two wires to each other. It means that the pulse is counted by the rising edge. If necessary to count pulses on the falling edge, set the Reverse logic parameter to "ON".

In order to change the conversion rate, connect to the device, and from the settings menu select "Advanced" -> "Calibration" -> "Calibration parameters" -> "Select a channel" -> "Reverse logic".

## Sensor specific settings: Binary (ok / alarm) loggers

### Switch logic (NO/NC logic)

This group of sensors contain all devices, which react to the change of the state of the monitored value including: water leakage sensors and open / close sensors. On top of the standard features, users can define the logic of the binary sensors - decide, if the switches shall behave as normally open (NO) or normally close (NC).

- Normally open (NO) - a normally open contact is the one that remains open until a certain condition is satisfied. This is how the water leakage loggers behave - if there is now water, the switch is opened and the logger is in the "ok" state. Once the water leak is detected, the switch closes, and the logger changes its state to "alarm".
- Normally closed (NC) - a normally closed contact is the one that remains closed until a certain condition is satisfied. This is how the open / closed loggers behave - if the door is closed, the switch is closed and the logger is in the "ok" state. Once the door opens, the switch opens, and the logger changes its state to "alarm".

In order to change the switch logic, connect to the device, and from the settings menu select "Advanced" -> "Calibration" -> "Calibration parameters" -> "Select a channel" -> "Reversed logic".

## Sensor specific settings: Water leak sensor

The water leakage detection is based on the voltage drop. When the external probe (water rope) is completely dry the measurement result is between maximum and minimum voltage thresholds. Once the rope is immersed in water, the device detects the voltage drop. If the voltage drops below the minimum threshold the device will change its state to “ALARM”. Efento water leak sensors come pre-calibrated and the initial calibration is not required. If the device is not sufficiently sensitive to flooding the probe, the minimum threshold may be increased. If the device changes its state despite the dry probe, increase the maximum threshold but first make sure that the probe is not damaged.

**Maximum treshold 100%**

**Minimum treshold 75%**

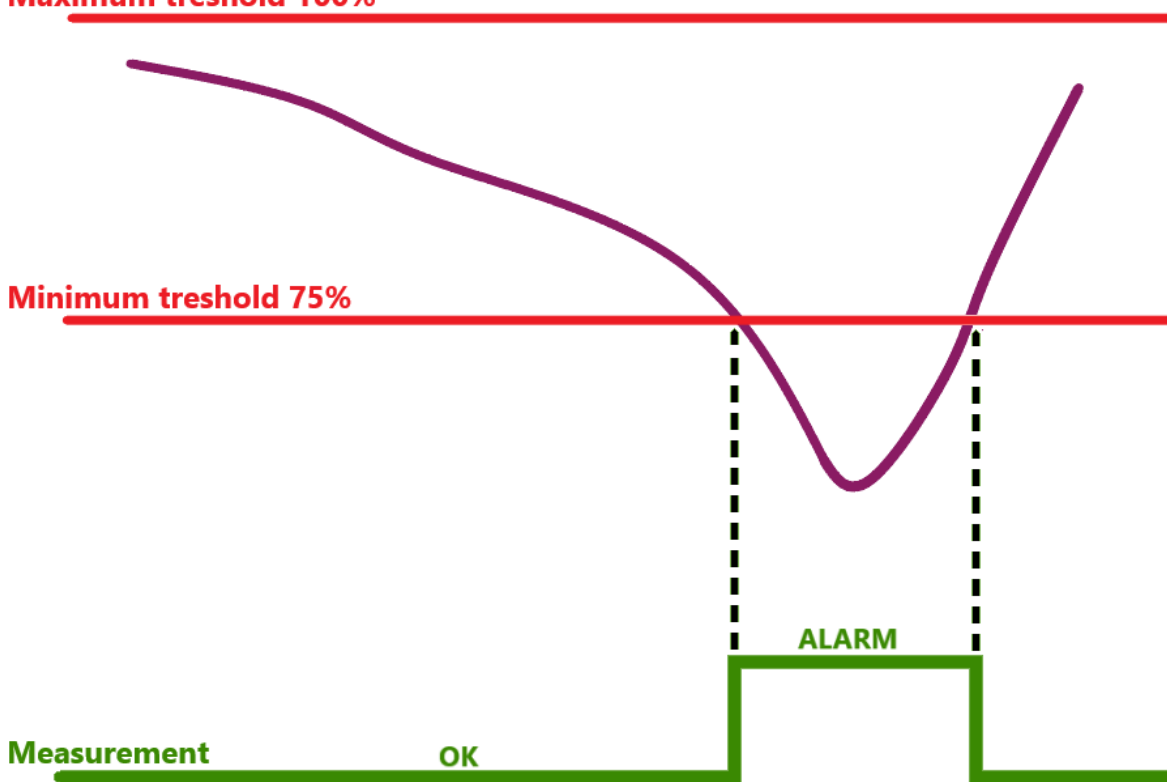

The range of the voltage values that define the correct measurements range (when the sensor shows “OK”) is defined as percentage of the maximum voltage measured, by two calibration parameters:



## Minimum threshold (%)

It determines the minimum voltage value within the range corresponding to the correct measurement (without triggering an ALARM). By default set to 75%.

## Maximum threshold (%)

It determines the maximum voltage value within the range corresponding to the correct measurement (without triggering an ALARM). By default set to 100%.



### Important!

- **Minimum threshold cannot be larger than maximum threshold**
- **Maximum threshold cannot be smaller than minimum threshold**

## Reversed logic

By default, if the water leak probe is dry, the sensor will report an “OK” state. If the probe is wet, it will report an “ALARM” state. It is possible to revert the logic (dry probe = ALARM, wet probe = OK).

Calibration settings described above can be done using the mobile application. Connect to the sensor -> settings (three dots in the upper right corner -> “Advanced” -> ”Calibration” -> “Calibration parameters” -> “Select a channel” -> “Reversed logic”.

## Sensor specific settings: CO2 sensor

Efento CO2 sensor requires calibration to properly measure CO2 concentration. The device supports two types of calibration: manual (on demand) and automatic. Manual calibration should always be performed before installing the device. Automatic calibration is performed once a week, at the time defined by the user in order to adjust the sensor's sensitivity.

## Manual calibration

Manual calibration is performed in a known CO<sub>2</sub> concentration and is required to reduce the measurements offset. Calibration can be either performed using a gas cylinder with a known CO<sub>2</sub> concentration or in the fresh air (outdoor). Before performing the calibration leave the device in a place with known CO<sub>2</sub> concentration for at least 15 minutes.



**Make sure to calibrate the sensor before using it! Without the calibration the sensor's accuracy is low and the measurements taken by the sensor are not reliable!**

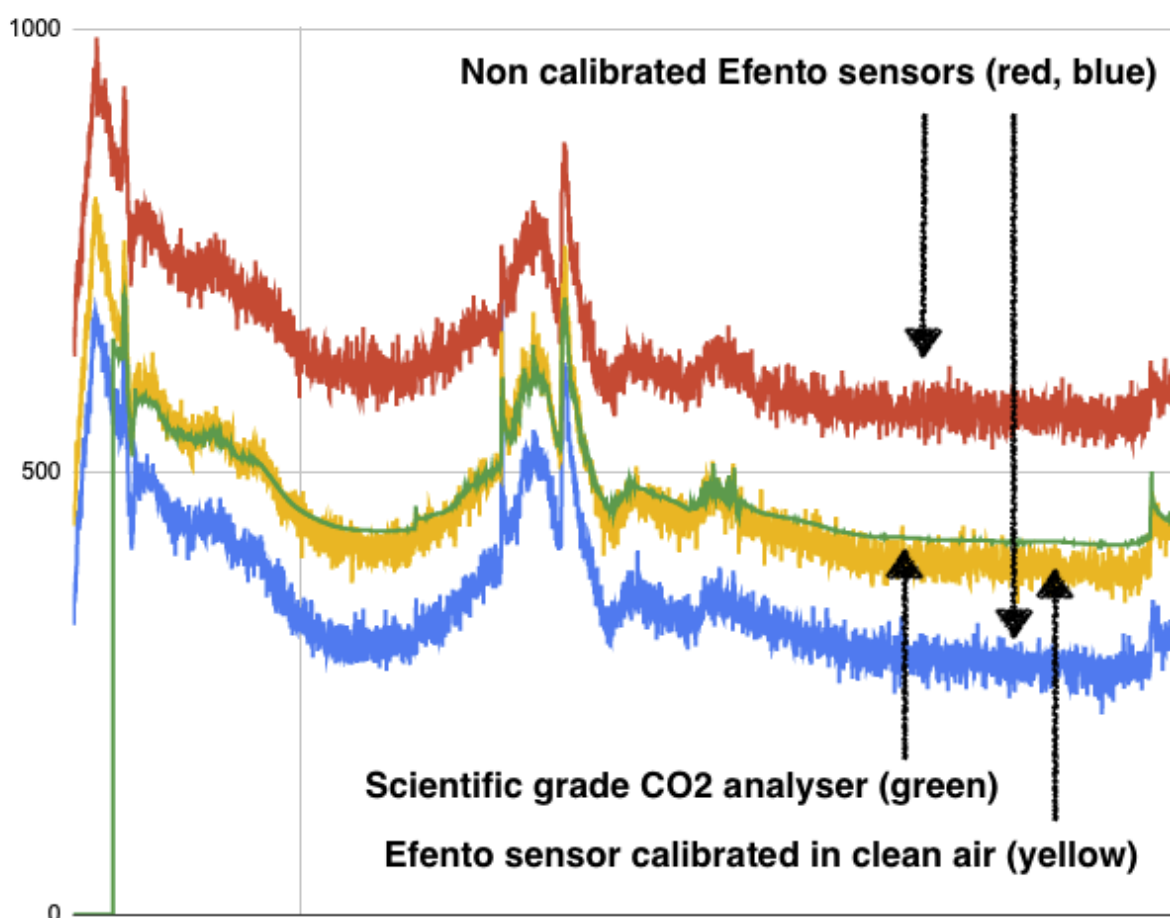

*Sensor's calibration is required in order to provide reliable CO<sub>2</sub> measurements*

In order to calibrate the sensor connect to it with Android application -> settings (three dots in the upper right corner) -> "Advanced" -> "Calibration" -> "Manual calibration" -> "Select a channel". Key in the concentration of the CO<sub>2</sub> in the place where the sensor is located:

- Fresh air calibration- the average concentration of the CO<sub>2</sub> in the atmosphere is 420 ppm. Key in that value in the application. Please note that the concentration of the CO<sub>2</sub> varies between places, time of the day and time of the year. Therefore the calibration in the clean air does not guarantee the best possible accuracy
- Calibration with a gas cylinder - in the application key in the concentration of the gas in the reference cylinder used for the calibration

## Automatic calibration

Automatic calibration is performed by the sensor once a week at the scheduled time (e.g. every Sunday at 2 AM). Make sure to pick the date when the air in the room where the sensor is located is clean (there are no people in the room, there was enough time to ventilate the room). For the majority of the use cases (office, schools, etc.) the best time for the automatic calibration is Sunday night. In order to change the settings of the automatic calibration use the mobile application. Connect to the sensor -> settings (three dots in the upper right corner -> "Advanced" -> "Calibration" -> "Calibration parameters" -> "Select a channel" -> "Automatic". Set the time, when the device should auto calibrate and the expected CO<sub>2</sub> concentration at that time (for majority of cases the auto calibration will be performed in the fresh air, so the expected concentration should be set to 420).

## Sampling settings

At each measurement, the device can take a few samples and calculate the average value in order to increase the measurement accuracy. This allows to reduce the noise but decreases the battery life time. Users can decide how many samples should be taken at each measurement and how the samples should be proceeded. It is possible to set the following parameters:

- Number of samples - how many samples are taken at each measurement and are used to compute the average value
- Remove min / max samples - if this option is selected, the device will remove the lowest and the highest sample and calculate the average out of the remaining samples. Example: device is set to take four samples at each measurement. Measured CO<sub>2</sub> concentrations: 450, 504, 508, 550. If the min and max values are removed, the average will be computed from two samples - 504 and 508 and the device will return the measurement value: 506 ppm.

Sampling settings can be changed with the mobile application. Connect to the sensor -> settings (three dots in the upper right corner -> "Advanced" -> "Calibration" -> "Calibration parameters" -> "Select a channel" -> "Manual".



**Important! Increasing the number of samples taken at each measurement decreases the battery life time!**

---

## Sensor specific settings: Barometric pressure

### Oversampling settings

At each measurement, the device can take a few samples and calculate the average value in order to increase the measurement accuracy. This allows to reduce the noise but decreases the battery life time. Users can decide how many samples should be taken at each measurement and how the samples should be proceeded. It is possible to select one of the six oversampling options: disabled (one sample per measurement) 2, 4, 8, 16, 32.

In order to change the oversampling, connect to the device, and from the settings menu select “Advanced” -> “Calibration” -> “Calibration parameters” -> “Select a channel” -> “Number of samples per measurement”.

## Sensor specific settings: High and low temperature

High and low temperature Efento sensors are suitable for measuring non-standard temperature values (from -200stC to 800stC). The temperature range that the device will support depends on the external probe used. The difference between the high temperature probe and the low temperature probe includes the insulation material of the cable. Efento high and low temperature sensors come pre-calibrated and the initial calibration is not required.

### PT type sensor parameter

When the external probe needs to be changed this parameter enables choosing the type of probe used in the device.

- 0 - PT10 sensor
- 1 - PT50 sensor
- 2 - PT100 sensor
- 3 - PT200 sensor
- 4 - PT500 sensor
- 5 - PT1000 sensor

---

## Sensor curve type

For each type of RTD (Resistance Temperature Detector) curve there is an equation that describes the relationship between resistance (R) and temperature (T) of RTD. The type of the curve depends on the material the probe is made of and is used for calculating temperature values based on resistance.

- 0 - European standard
- 1 - American
- 2 - Japanese
- 3 - ITS 90

## Excitation current parameter

When the probe will be replaced with another one it is possible to change the excitation current. The current values for the probes can be found in technical documentation of LTC2983.

- 0 - 5 [uA]
- 1 - 10 [uA]
- 2 - 25 [uA]
- 3 - 50 [uA]
- 4 - 100 [uA]
- 5 - 250 [uA]
- 6 - 500 [uA]
- 7 - 1 [mA]

## Extra delay multiplier

In case of additional capacities, caused by e.g. changing the RTD probe to a longer one, this parameter is responsible for changing the time required to compensate for the charging of the capacitors used in the measurement circuit ( $x * 100\mu s$ )

- $x = [0 : 255]$  - valid range of ED

## Sensor specific settings: Soil moisture

Soil moisture sensor shows values in the range between -200kPa and 0kPa. Efento soil moisture sensors come pre-calibrated and the initial calibration is not required. However, during the operations the accuracy may decrease and recalibration may be required. Recalibration can be performed by the user. In order to calibrate the sensor, place the soil moisture probe in a vessel with water, so that it is completely submerged. If the sensor shows values other than 0kPa, calibrate it by setting the value of "Measure offset" to 0 kPa.

This process can be done using a mobile application. Connect to the sensor -> settings (three dots in the upper right corner -> "Advanced" -> "Calibration" -> "Calibration parameters" -> "Select a channel" -> "Measurement offset".

**Important!**

- **Wet soil moisture probe should read 0kPa**
- **Dry soil moisture probe should read -200kPa (it takes up to 24 hours for the probe to dry completely)**

## Sensor specific settings: Motion / presence sensor

Motion / presence sensors are used to detect movement or presence of person(s) in the room. The sensor is of the binary type and can have two states:

- 0 (OK) - no presence detected,
- 1 (ALARM) - presence detected

It is possible to set the following parameters for this type of sensor:

- **Sensitivity threshold: movement** - number of movements detected in a measurement period that are required to mark the period of time with the "1" flag (presence detected). Number of movements is compared against this threshold, if the sensor is in the "no presence detected" state (e.g. "if the number of movements detected in a measurement period is larger than 3, mark it as 1").
- **Sensitivity threshold: no movement** - number of movements detected in a measurement period that are required to mark the period of time with the "0" flag (no presence detected). Number of movements is compared against this threshold, if the sensor is in the "presence detected" state (e.g. "if the number of movements detected in a measurement period is lower than 2, mark it as 0").
- **Consecutive measurement periods: movement** - number of the consecutive measurement periods with "1" flag required to change the sensor state to "presence detected" (e.g. "if the number of the consecutive measurement periods with "1" flag is larger than 1, change the sensor state to "presence detected").
- **Consecutive measurement periods: no movement** - number of the consecutive measurement periods with "0" flag required to change the sensor state to "no presence detected" (e.g. "if the number of the consecutive measurement periods with "0" flag is larger than 1, change the sensor state to "presence not detected").

The way the sensor works:

1. User defines a measurement interval
2. Sensor counts the number of movements in the measurement period

3. Sensor checks, if the number of movements in the measurement period is over the sensitivity threshold set
  - a. If the number of the movements is over the sensitivity threshold, sensor marks the period of time with "1" flag (movement detected)
  - b. If the number of the movements is below the sensitivity threshold, sensor marks the period of time with "0" flag (movement not detected)
4. Sensor checks, if the number of the consecutive measurement periods with "1" or "0" flag is above or below the consecutive measurement periods threshold
  - a. If the number of the consecutive measurement periods with "1" is over the threshold, sensor will set its state to "1" - presence detected
  - b. If the number of the consecutive measurement periods with "1" is below the threshold, sensor will not change its state
  - c. If the number of the consecutive measurement periods with "0" is over the threshold, sensor will set its state to "0" - presence not detected
  - d. If the number of the consecutive measurement periods with "0" is below the threshold, sensor will not change its state

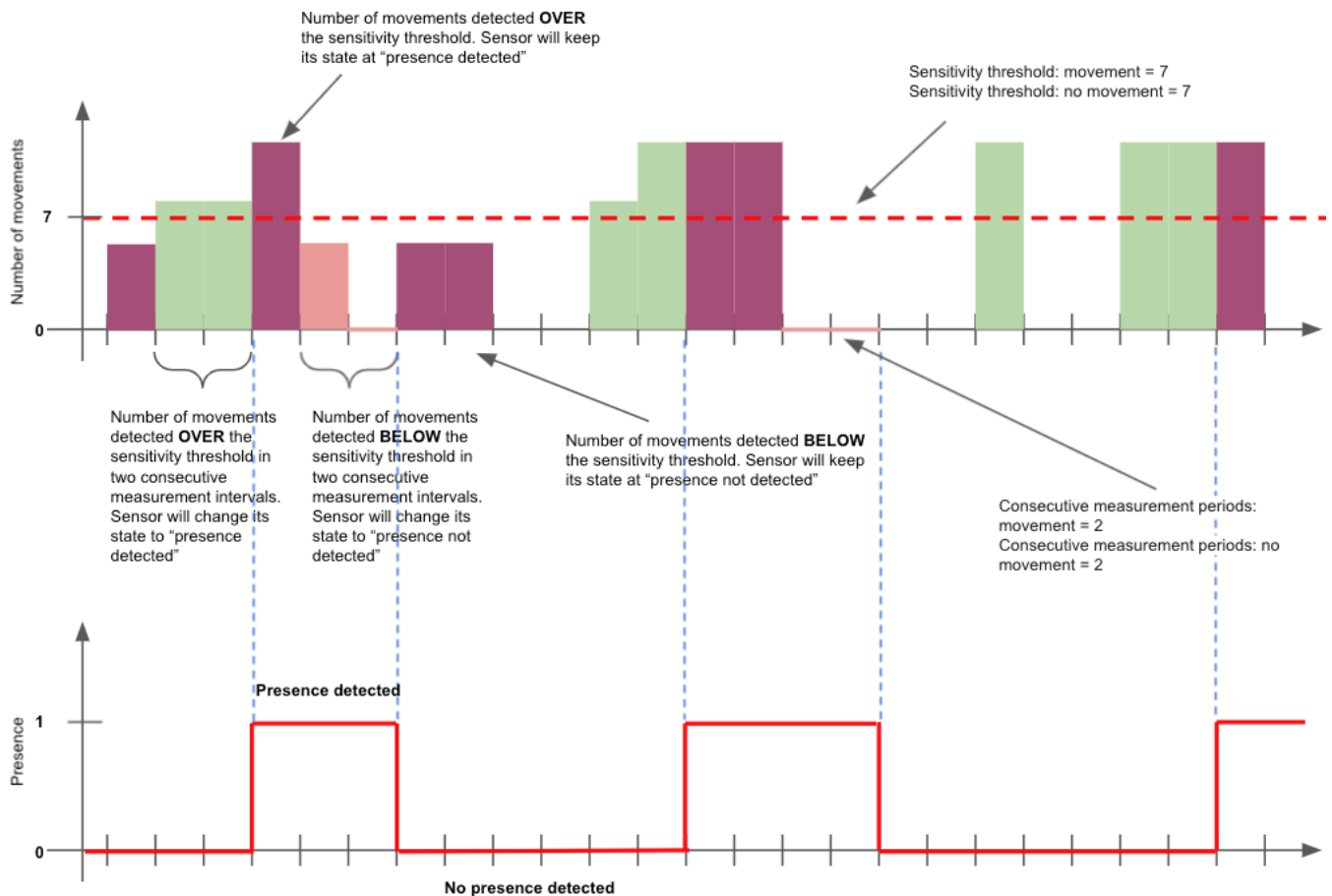

If the sensor shall be used as a regular movement sensor (change its state, if a movement has been detected), use the following settings:

- Sensitivity threshold: movement = 1

- Sensitivity threshold: no movement = 0
- Consecutive measurement periods: movement = 1
- Consecutive measurement periods: no movement = 1

All the other settings are used in case of the presence sensor and allow to filter out short movements, that would result in a false positive detection that a room is occupied (e.g. a person opens and closes a conference room door, would result in changing the sensor state to "presence detected") or false-negative detection that a room is not occupied (e.g. a person sits still in a room for a while, would result in changing the sensor state to "presence not detected"). These settings can be adjusted depending on the specification of the room, in which the sensor is used.

All the settings described above can be set with the mobile application. In the upper right corner settings (three dots in the upper right corner -> Advanced -> "Calibration" -> "Calibration parameters" -> "Select a channel").

## Reversed logic

Motion sensor normally signals the detection of the motion by high state which results in sending over Bluetooth / NB-IoT displaying "ALARM" status. Enabling this function will reverse the logic and the motion detection sensor will indicate the status "OK".

## Security

Wireless communication via the Bluetooth Low Energy interface can be encrypted. If the encryption is turned on, then mobile devices that do not have an encryption key compatible with the key, with which the communication is encrypted cannot read any data sent by the logger. Additionally, it is possible to automatically turn off the Bluetooth Low Energy interface after the desired time from starting the logger. Thanks to this, it will not be possible to connect to the logger using devices equipped with the Bluetooth Low Energy interface.

Data transmission in the NB-IoT network is encrypted and therefore safe. The data security problem appears at the stage of data transfer via the Internet - between the NB-IoT network and Efento Cloud / user server. NB-IoT is based on the UDP protocol, which is supposed to be lightweight. Adding security features to this protocol (e.g. encryption) increases the size of sent UDP frames, and thus the device's battery consumption. The solution that ensures safe data transmission from the logger to the server is the use of an APN configured by the network operator and a secure tunnel (VPN) configuration between the APN and Efento Cloud / client's server. Then the data is still sent using the light UDP protocol, without increasing energy consumption, and thanks to the use of a tunnel, it cannot be eavesdropped on during its transmission over the public Internet.

## Power saving features

In order to ensure maximum battery saving, the logger is set to PSM = 0, eDRX = disabled. This means that the device will finish the transmission automatically after sending data to the server and (possibly)



receiving a new configuration from it. The device does not stay awake waiting for additional transmission from the server. The only possible way to transfer data from the server to the logger is to send them in response to the data packet received from the logger.

The NB-IoT standard provides for the retry of data transmission, if it is impossible to send it correctly. The method of repeating the transmission is not configurable by the user, it is done automatically by the logger. The number of retries is determined by the ECL (Coverage Enhancement Level) parameter, which specifies the number of retries of failed transmission attempts defined as  $2^i$  ( $i = 1 \dots 7$ ). The parameter is set from 0 (normal operation) to 2 (bad signal quality / high noise, large number of retransmissions required). The higher the ECL value, the higher the energy cost of sending data, and therefore the shorter the battery life. When installing the NB-IoT logger, it is worth checking the ECL level in the place where it is to work (the issue is described in "Device status" section).

NB-IoT devices should not move between base stations, as this results in the need to re-register to the network each time the base station changes. The registration process takes a relatively long time, therefore frequent relocation of the logger between base stations adversely affects the battery life.

## Data usage

The amount of data sent and received by the logger depends mainly on the measurement interval and the transmission interval. For example, a logger that measures only the temperature, performs a measurement every 3 minutes, sends data every 3 hours, and four times a month sends data because of exceeding the thresholds, consumes 60.5 kB per month. The same settings for a temperature and humidity logger will require 89.3 KB of data per month. It is safe to assume that the monthly data usage of a single device with three slots is 150 kB. This includes firmware updates and configuration changes.

## Battery life

The battery life of a device depends on many factors and it is not easy to build a model that will precisely determine this time. Efento NB-IoT loggers battery life time is up to 10 years or 130,000 transmissions (standard battery pack: 2 x AA batteries, 4200 mAh).

The main factors affecting battery life are:

- **Signal quality** - the worse the signal quality, the greater the number of retransmissions is necessary to send data to the server. The number of retransmissions is represented by the ECL parameter and battery life is significantly reduced at higher ECL values (1 or 2)
- **Transmission period** - the more frequent the transmissions, the shorter the battery life of the device. With brand new battery pack, the device should send data about 130,000 times (2 batteries in a battery pack) or 195 000 times (3 batteries in a battery pack) (assumptions: room temperature, ECL = 0, 20 measurements / transmission, transmission period small enough to make 130,000 transmissions within 10 years)

- **Ambient temperature** - in lower temperatures the batteries discharge faster. Lithium-ion batteries used in Efento loggers should not operate beyond the range specified in the device's technical card

The table below presents expected battery life time and monthly data usage depending on the settings and signal conditions (ECL). The values below are values for a temperature and humidity logger.

**CAUTION:**

**Efento recommends to treat the battery life time calculations indicatively, and always assume that the real battery life time will be shorter due to many factors, which could not be included in the model.**



**The table below shows data for a standard battery pack of 2 batteries (4200 mAh). In the case of a battery pack made of 3 batteries (6300 mAh), battery life time increases by 50%.**

Measurement interval [min]	Transmission interval [min]	ACK period (every N messages)	Bluetooth interface	Battery lifetime [years]**			Data usage (up + down)*
				ECL = 0	ECL = 1	ECL = 2	
15	60	24	OFF	11	7.5	5	106 kB
			ON	6.2	4.6	3.5	
3	30	12	OFF	6	3.7	2.5	252 kB
			ON	4.1	2.8	2	
3	180	8	OFF	11	11	9	90 kB
			ON	8	6.3	5.1	
5	60	1	OFF	3.1	1.9	1.2	182 kB
			ON	2.5	1.7	1.1	
5	60	24	OFF	6.2	4.7	3.6	130 kB
			ON	6.2	4.7	3.6	

\* Table above presents maximum uplink data usage.

- Due to a compression algorithm, real data uplink data may be up to 25% lower compared to the values from the table above
- Downlink data does not take into the account configuration changes sent to the logger from the server and FOTA updates

\*\* Battery consumption is indicative. Battery lifetime is affected by many factors including:

- temperature, in which the device operates
- signal conditions
- type of sensors installed in the device
- number of BLE connections (i.e. to download the data from devcie's memory)
- number of user / threshold triggered transmissions
- number of new configurations sent from the server to the logger
- number of network registrations (if device changes its location, resets, there are some network issues, device needs to register to the network again what consumes a lot of battery)
- number of FOTA updates (not included in the model)
- complex physics of Li-ion batteries (in the model a simplified calculation is used). Due to physical processes which happen in the battery, maximum battery life time is 11 years. After that time, the battery will discharge, even if it is not used

## Qualification and approvals

### European Union regulatory compliance

Information about European Union regulatory compliance for Efento NB-IoT wireless loggers is available in the [Declaration of Conformity](#).

### Compliance with the RoHS directive

Efento Bluetooth Low Energy loggers comply with the "Directive 2015/863/EU" (RoHS 3) of the European Parliament and the Council on the Restriction of Use of certain Hazardous Substances in Electrical and Electronic Equipment (RoHS).